

	Bedeutung der Kurzzeichen	Meaning of the symbols
C	Kondensator	capacitor
E	Elektronik-Baustein	Electronic unit
M	Motor	Motor
S	Schalter	Switch
BK	Schwarz	Black
BN	Braun	Brown
BU	Blau	Blue
GY	Grau	Grey

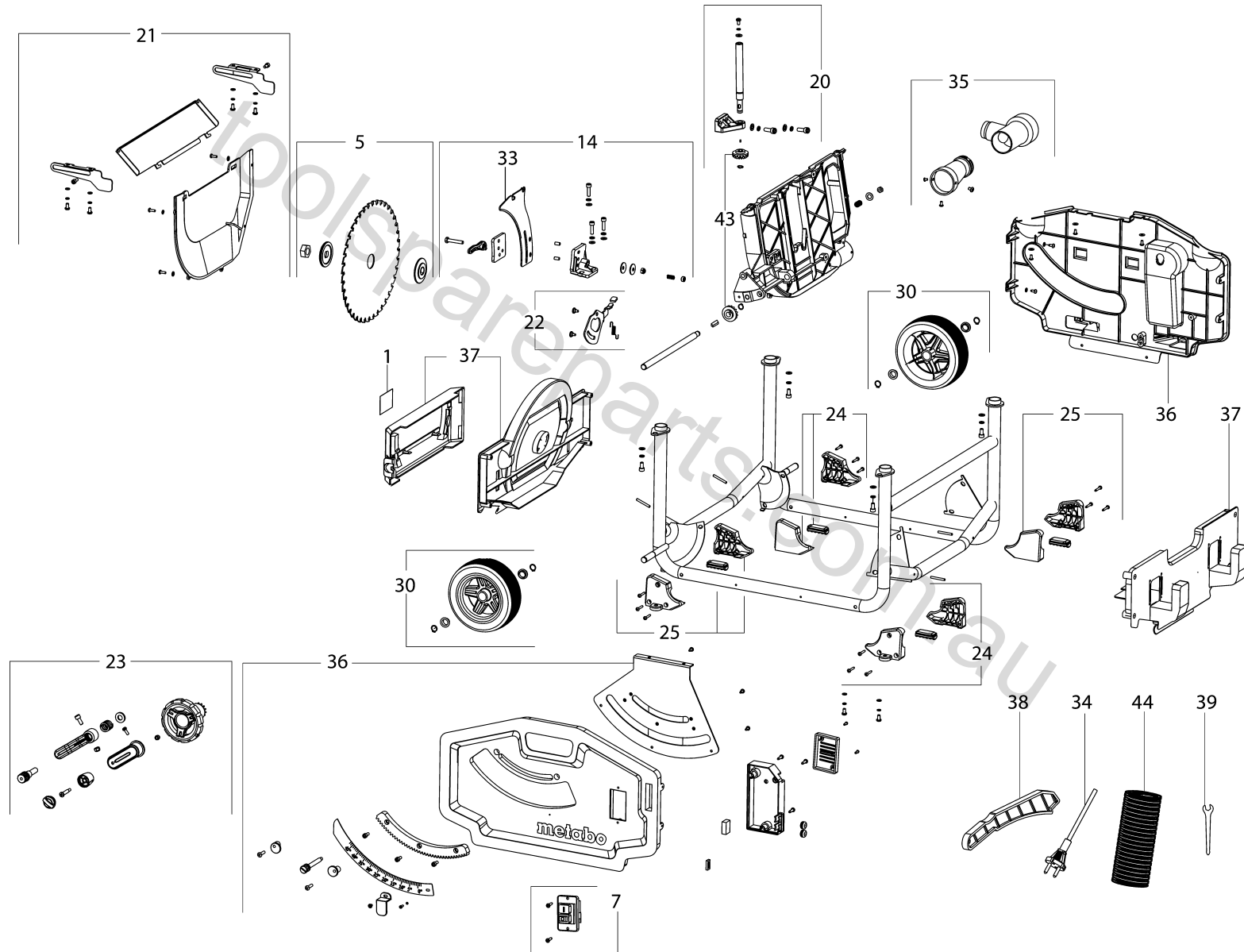

Position	Amount	Type number	Description	PG
1	1	338057640	Rating plate	10
2	1	338123720	Hinweisschild Funktionserklärung Lock	10
3	1	338123670	Scale	15
4	1	316052410	Table insert compl.	24
5	1	316052420	BLADE COLLAR	19
6	1	316052430	Wheel guard compl.	23
7	1	343409960	Switch	26
8	1	315418220	Table side extension compl.	42
9	1	316052440	Table extension compl.	31
10	1	316052450	Parallel guide compl.	37
11	1	341161460	Guide rail	30
12	1	331050830	Parallel guide (Lever ass'y)	17
13	1	316052460	Angular guide compl.	31
14	1	316052470	Riving knife compl.	26
15	1	316052480	Motor compl.	56
16	1	310010690	Armature w. Ball bearing	41
17	1	316052490	Gear-box compl.	29
18	2	343001190	Brush holder	17
19	2	343013100	Carbon brush	17
20	1	316052500	HEIGHT-ADJUSTMENT	24
21	1	343433170	Saw blade cover lower	25
22	1	316052510	Spindle stop compl.	16
23	1	316052520	Handwheel compl.	22
24	1	344099440	Rubber foot right	14
25	1	344099450	Rubber foot left	14
26	1	316052530	JOINT ARM left, cpl.	35
27	1	316052540	JOINT ARM right, cpl.	36
28	1	344099460	leg adjustable	27
29	1	316052570	Leg cpl.	29
30	1	316052580	Wheel compl.	26
31	1	316052590	Table compl.	54
32	1	316052600	Guide Swivelling frame compl.	19
33	1	339135490	Riving knife	18
34	1	344499240	Cable with plug	29
35	1	316052610	Exhaust nozzle compl.	15
36	1	316052620	Housing compl.	35
37	1	316052630	Saw blade depot	31
38	1	343433180	Push stick	15
39	1	341210480	Key	13
40	1	340033540	Bevel gear	29
41	1	320050750	Ball bearing	15

42	1	320050760	Ball bearing	15
43	1	340033550	Bevel gear set	18
44	1	344099620	Suction hose	27
45	1	316054750	GLIDE PIECE cpl.	19
46	1	343083300	Electronic unit	
1001	1	338505650	Wiring Diagram	

toolspareparts.com.au

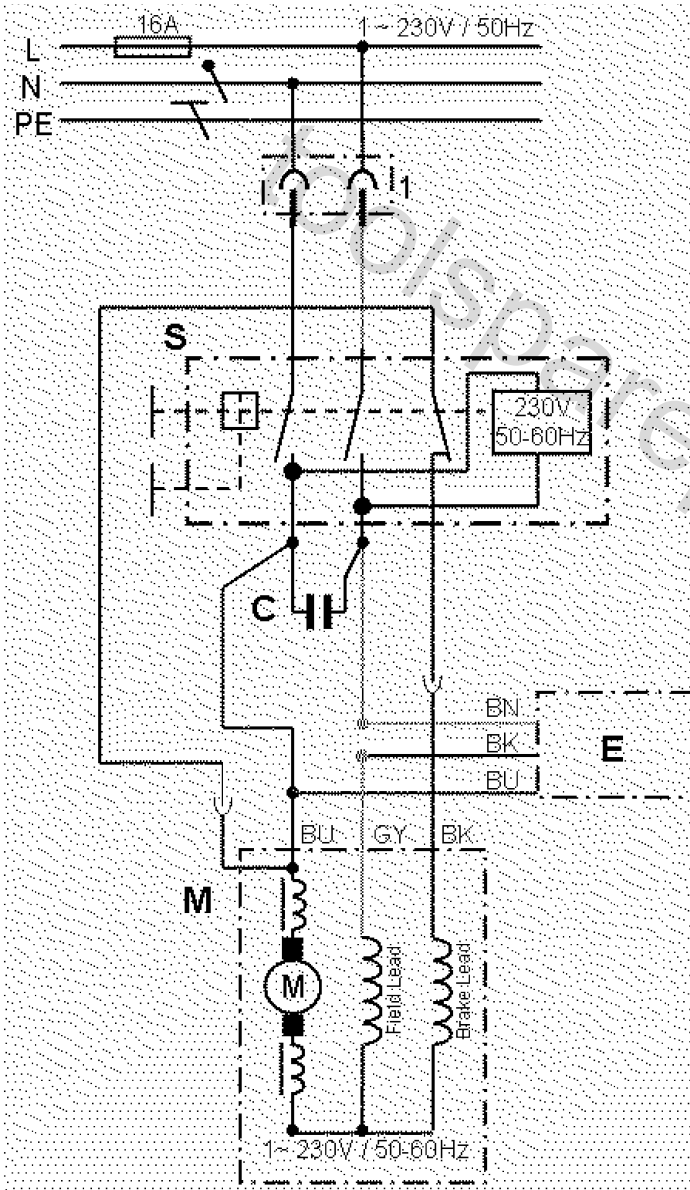

	Bedeutung der Kurzzeichen	Meaning of the symbols
C	Kondensator	capacitor
E	Elektronik-Baustein	Electronic unit
M	Motor	Motor
S	Schalter	Switch
BK	Schwarz	Black
BN	Braun	Brown
BU	Blau	Blue
GY	Grau	Grey